



SERIE KLIA

porte su muratura e cartongesso
doors on masonry and plasterboard



. specifiche / specifications

CARATTERISTICHE STRUTTURALI

Struttura

Porte a battente realizzate con profili arrotondati ad imbotte in Alluminio nelle varie finiture.

Le porte si possono installare su profondità (muro/cartongesso) variabili a partire da mm 75 fino a coprire lo spessore richiesto.

Sono esclusi i controtelai in legno necessari per installazione.

Ante

Serie Klia con stipite R40

Cieche:

- con ante intelaiate in alluminio R40 con o senza fascia con doppi pannelli in conglomerato di legno nobilitato sp.12. mm finiture da catalogo.

Vetrate:

- con ante intelaiate in alluminio R40 con o senza fascia con vetro stratificato sp. 3+3 mm trasparente e guarnizioni colore grigio.

Le maniglie sono a leva (modello Ghidini serie Europa col. alluminio) con serratura o pomolo (modello premi/apri Meroni nova col. Alluminio e nero) con serratura / nottolino, cerniere apertura 180° colore alluminio.

Serie Klia con stipite Minimal

Cieche: con ante in legno tamburato sp. 44 mm senza intelaiatura finiture da catalogo.

Vetrate:

- con ante intelaiate in alluminio minimal 23/26 mm con vetro temprato sp.6/5+5 mm trasparente, e guarnizioni grigie.

- con ante in cristallo temprato sp. 10 mm filo lucido.

Le maniglie sono a leva (modello Hoppe, serie Arles (standard) - serie Paris con antimanica (su richiesta), colore alluminio con serratura/nottolino, cerniere apertura 180° colore alluminio.



Serie Klia con stipite Minimal



Serie Klia con stipite Minimal / Klia Series with Minimal doorpost

tipologie / types

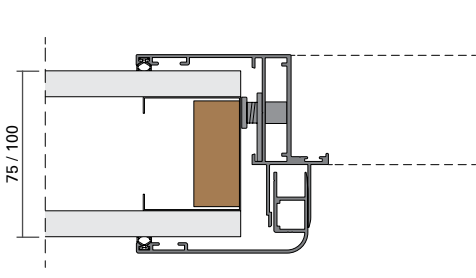

IMBOTTE JOLLY - spessore 75/100 mm /
JOLLY JAMB - thickness 75/100 mm

sezione orizzontale / horizontal section

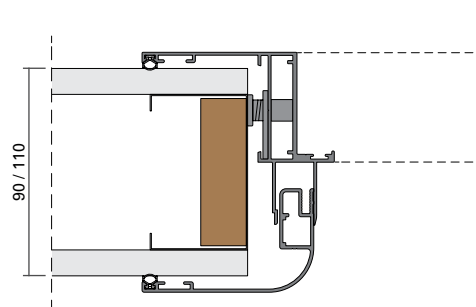

IMBOTTE 1 - spessore 90/110 mm /
JOLLY JAMB - thickness 90/110 mm

sezione orizzontale / horizontal section

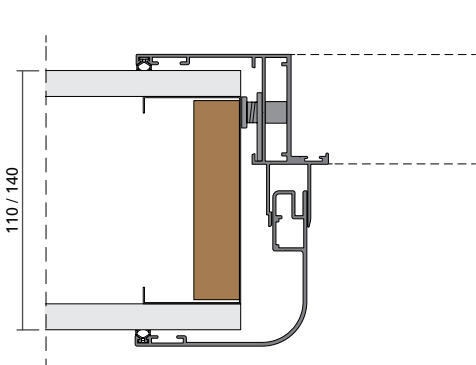

IMBOTTE 2 - spessore 110/140 mm /
JAMB 2 - thickness 110/140 mm

sezione orizzontale / horizontal section

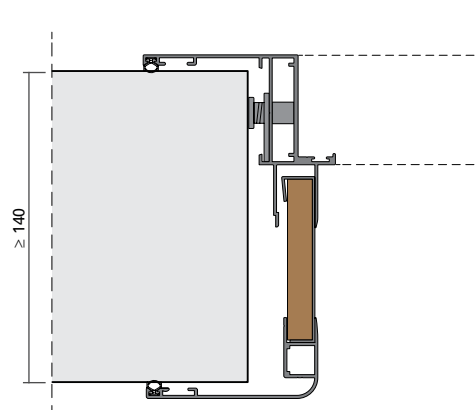

IMBOTTE JOLLY TELESCOPICA - spessore ≥ 140 mm /
ADJUSTABLE JOLLY JAMB - thickness ≥ 140 mm

sezione orizzontale / horizontal section

Porte disponibili per Serie Klia con stipite Minimal:

- cieche tamburate senza intelaiatura
- vetrate ante intelaiate in alluminio minimal
- vetrate filo lucido trasparente

Doors available for Klia Series system with Minimal doorpost:

- frameless honeycomb doors
- glazed doors with Minimal aluminium frame
- glazed doors with polished edge



. porta battente vetrata filo lucido /
swing glazed door with polished edge



dettaglio /
detail

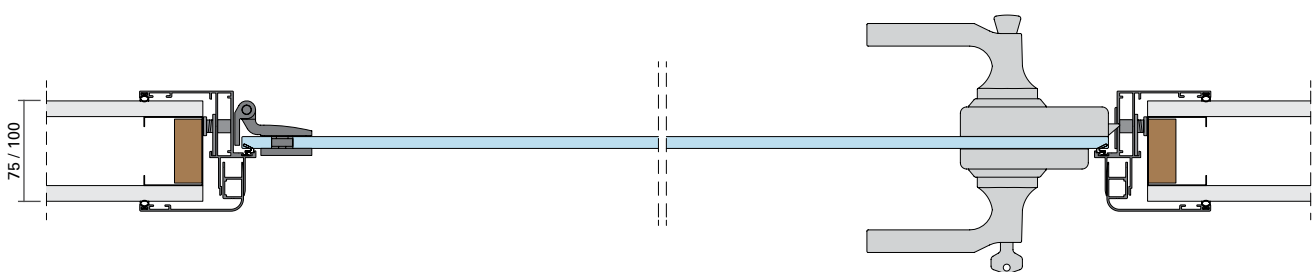

PORTA BATTENTE VETRATA FILO LUCIDO CON IMBOTTE JOLLY /
SWING GLAZED DOOR WITH POLISHED EDGE AND JOLLY JAMB

sezione orizzontale / *horizontal section*

. porta battente cieca tamburata /
frameless honeycomb doors



dettaglio /
detail

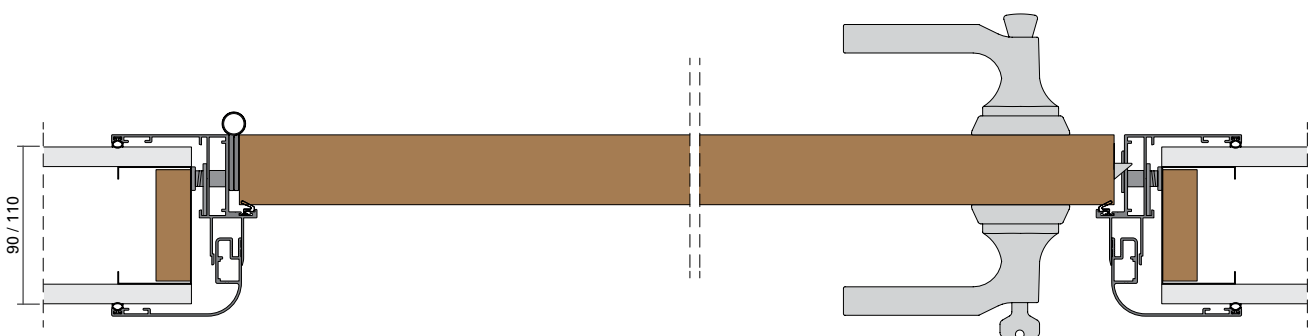

PORTA BATTENTE CIECA TAMBURATA CON IMBOTTE 1 /
FRAMELESS HONEYCOMB DOORS WITH JAMB 1

sezione orizzontale / *horizontal section*

. porta battente vetrata intelaiata minimal /
swing glazed door with minimal frame



dettaglio /
detail

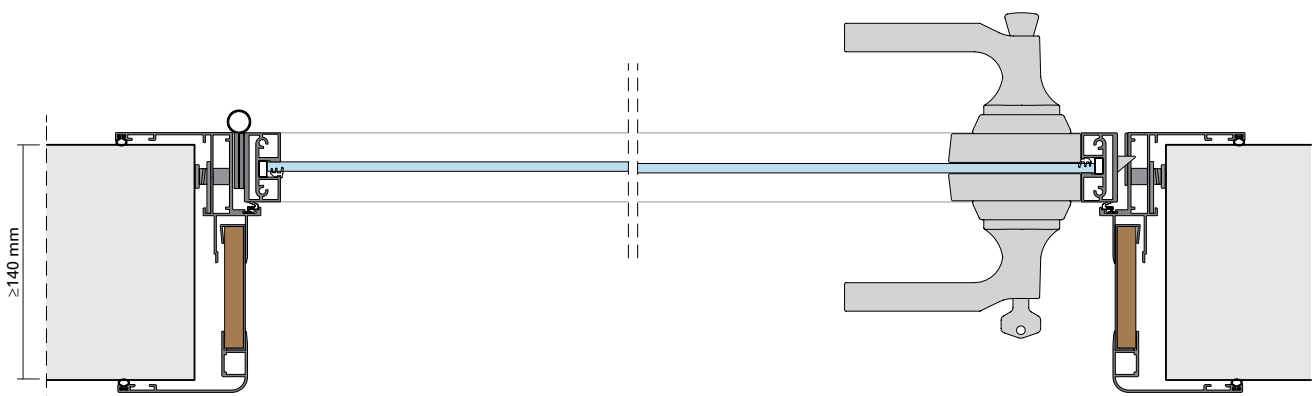

PORTA BATTENTE VETRATA INTELAIATA MINIMAL CON IMBOTTE JOLLY TELESCOPICO /
SWING GLAZED DOOR WITH MINIMAL FRAME AND ADJUSTABLE JOLLY JAMB

sezione orizzontale / *horizontal section*

Serie Klia con stipite R40



Serie Klia con stipite R40 / Klia Series with R40 doorpost

tipologie / types

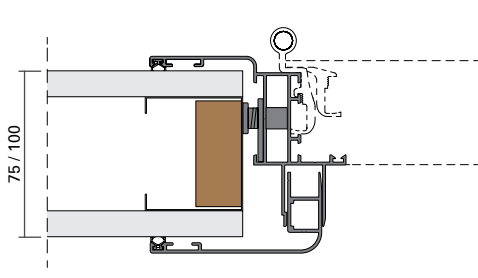

IMBOTTE JOLLY - spessore 75/100 mm /
JOLLY JAMB - thickness 75/100 mm

sezione orizzontale / horizontal section

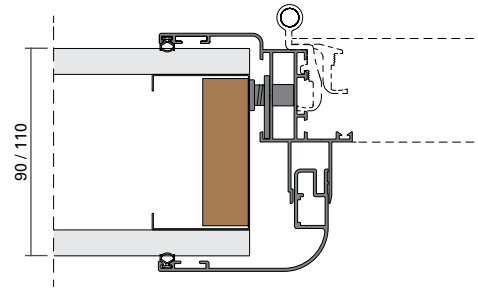

IMBOTTE 1 - spessore 90/110 mm /
JOLLY JAMB - thickness 90/110 mm

sezione orizzontale / horizontal section

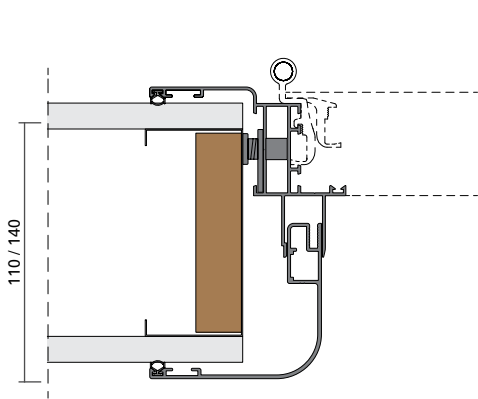

IMBOTTE 2 - spessore 110/140 mm /
JAMB 2 - thickness 110/140 mm

sezione orizzontale / horizontal section

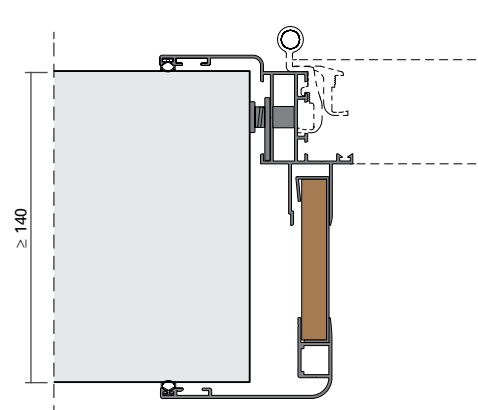

IMBOTTE JOLLY TELESCOPICA - spessore ≥ 140 mm /
ADJUSTABLE JOLLY JAMB - thickness ≥ 140 mm

sezione orizzontale / horizontal section

Porte disponibili per Serie Klia con stipite R40:

- cieche intelaiate in alluminio con o senza fascia
- vetrate con ante intelaiate in alluminio con o senza fascia

Doors available for Klia Series system with R40 doorpost:

- aluminium framed doors with or without infill panel
- glazed doors with aluminium frame, with or without infill panel

Porta con anta intelaiata con fascia /
aluminium framed doors with infill panel



dettaglio /
detail

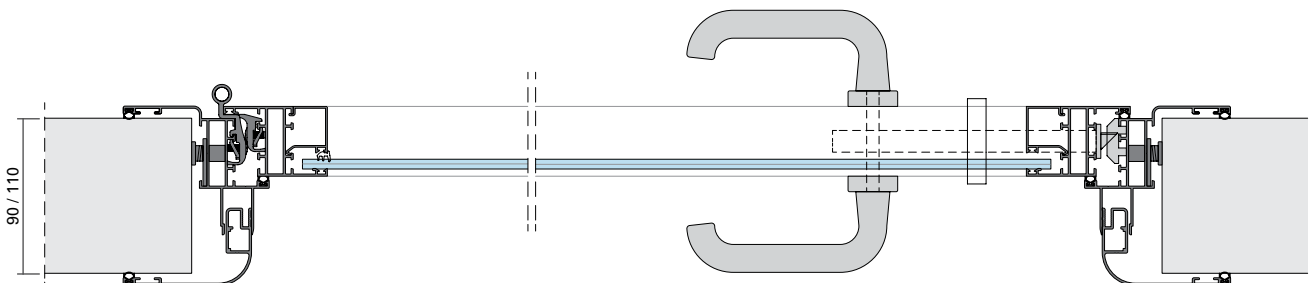

PORTA CON ANTA INTELAIATA CON FASCIA CON IMBOTTE 1 /
FRAMED DOOR WITH INFILL PANEL AND JAMB 1

sezione orizzontale / *horizontal section*

Porta con anta intelaiata con fascia /
aluminium framed doors with infill panel

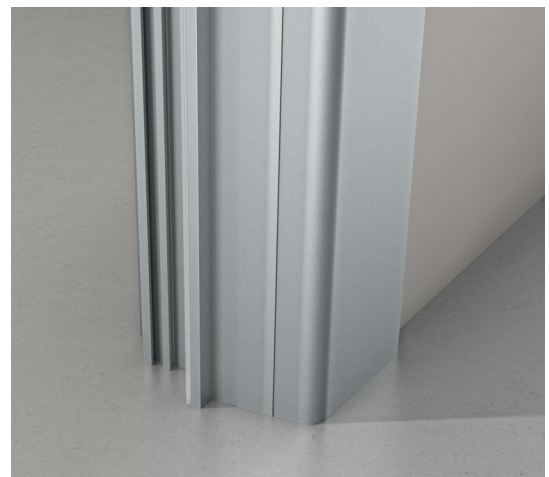

dettaglio /
detail

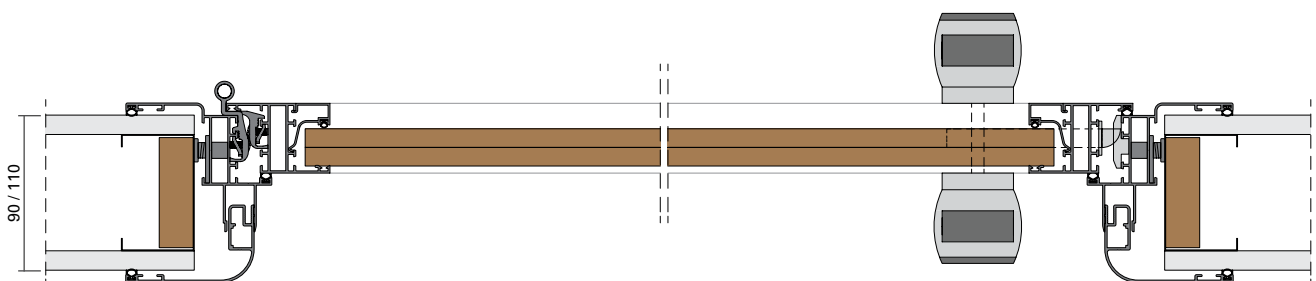

PORTA CON ANTA INTELAIATA CON FASCIA CON IMBOTTE 1 /
FRAMED DOOR WITH INFILL PANEL AND JAMB 1

sezione orizzontale / *horizontal section*



Porta vetrata con anta intelaiata /
glazed doors with aluminium frame



dettaglio /
detail

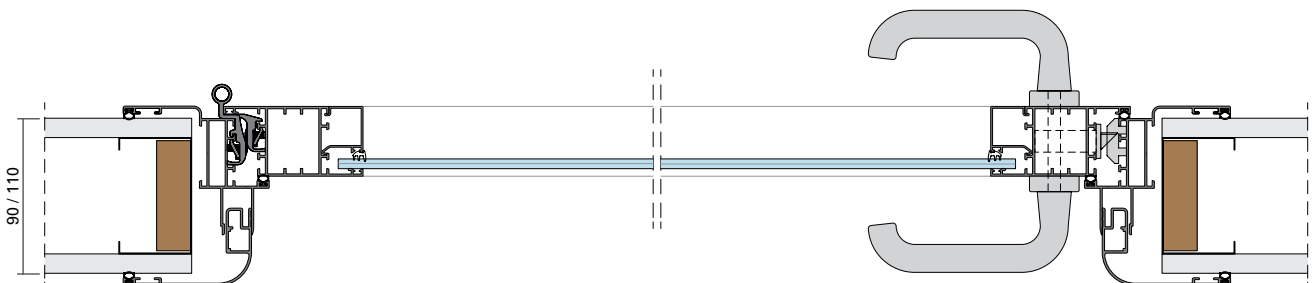

PORTA VETRATA CON ANTA INTELAIATA CON IMBOTTE 1 /
GLAZED DOOR WITH ALUMINIUM FRAME AND JAMB 1

sezione orizzontale / *horizontal section*



. abaco porte / *abaco doors*

Porte disponibili per Serie Klia con stipite R40 / *Doors available for Klia Series system with R40 doorpost:*

- cieche intelaiate in alluminio con o senza fascia / *aluminium framed doors with or without infill panel*
- vetrate con ante intelaiate in alluminio con o senza fascia / *glazed doors with aluminium frame, with or without infill panel*

Tutte le porte sono disponibili nella versione un battente e doppio battente. / *All doors are available in single door and double door version.*

Porte intelaiate cieche R40 / *R40 framed doors*

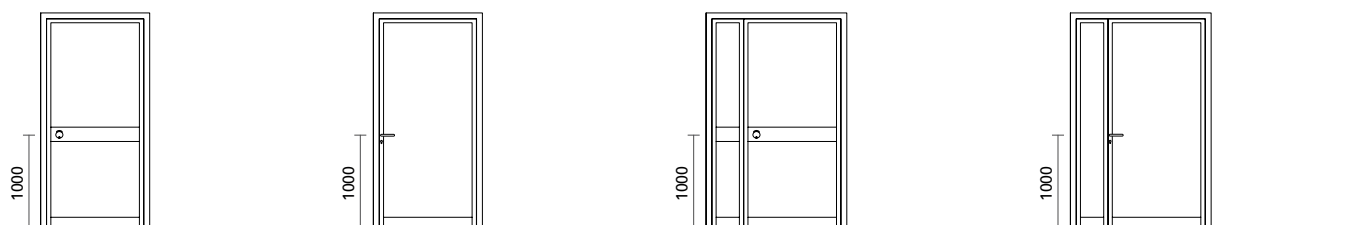

KP1c

KP2c

KP1cs

KP2cs

Porte intelaiate vetrate R40 / *R40 glazed framed doors*

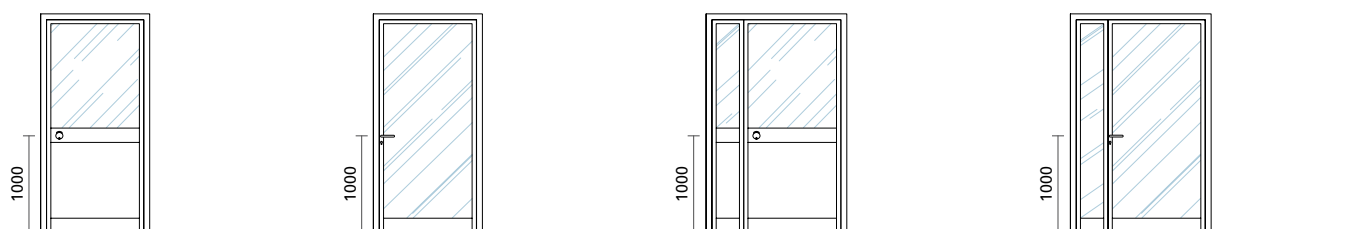

KP1v

KP2v

KP1vs

KP2vs

Porte disponibili per Serie Klia con stipite Minimal / *Doors available for Klia Series system with Minimal doorpost:*

- cieche tamburate senza intelaiatura / *frameless honeycomb doors*
- vetrate ante intelaiate in alluminio minimal / *glazed doors with Minimal aluminium frame*
- vetrate filo lucido trasparente / *glazed doors with polished edge*

Tutte le porte sono disponibili nella versione un battente e doppio battente. / *All doors are available in single door and double door version.*

Porte cieche tamburate / *Frameless honeycomb doors*

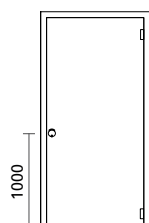

KP2ct

Porte vetrate filo lucido / *Glazed doors with polished edge*

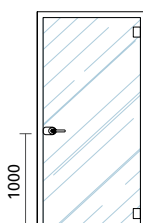

KP2vk

Porte vetrate intelaiate minimal / *Glazed doors with Minimal aluminium frame*

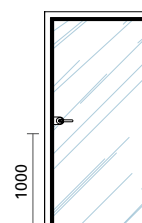

KP3vk

ATTENZIONE: Rilevare le misure del foro muro/cartongesso per dimensionare la porta.
PLEASE NOTE: measure the masonry/plasterboard wall rough opening to size the door.

. apertura porte / door opening

SENSO DI APERTURA PORTE A TIRARE / PULL TO OPEN

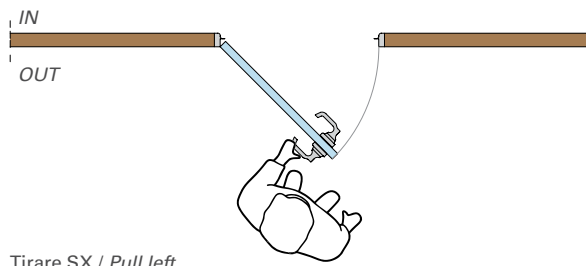
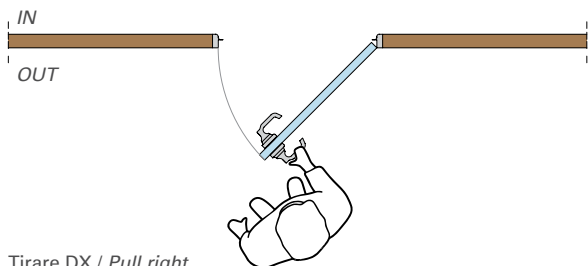

SENSO DI APERTURA PORTE A SPINGERE / PUSH TO OPEN

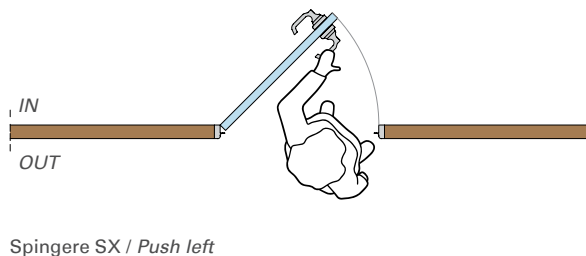
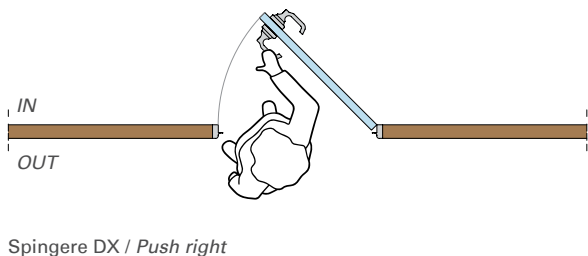



Fipe System srl
Via Guido Rossa, 6 20815 Cogliate (MB) Italy
T +39 02 96469109 - info@fipesystem.com
fipesystem.com